

**STRONGER PERFORMANCE
ULTIMATE SUPERIORITY**

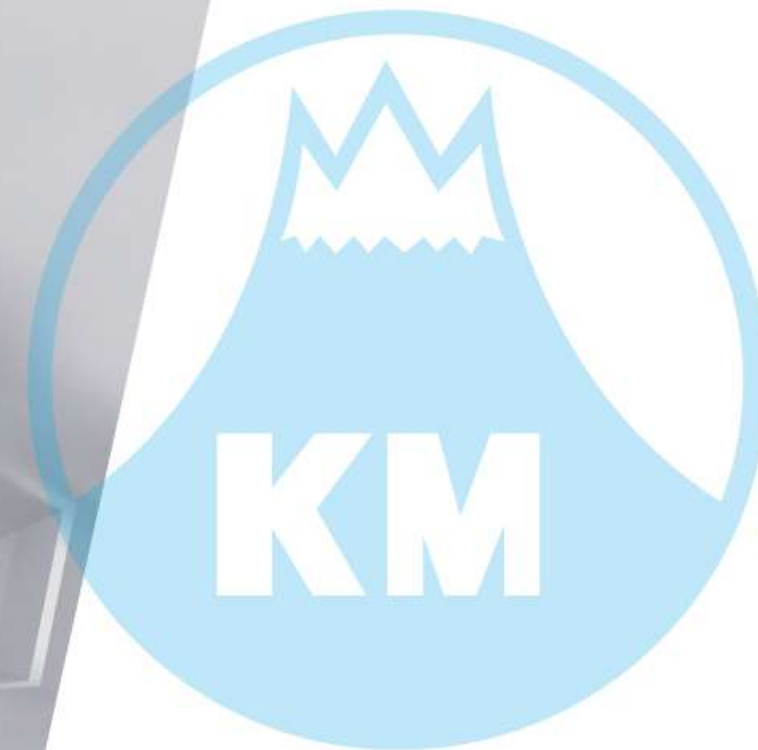

**BREAK INTO THE NEW STANDARD OF PERFECTION
KMC-M DOUBLE COLUMN MULTI CENTER**



- / KMC-M series is designed to meet the needs of multi-face machining for larger LCD molds and complex machine construction all in one single setup. That increases productivity and lowers cost.
- / All the three-axis travels are fully supported by box ways, ensuring machine rigidity and stability.
- / The three axes have larger travel ranges with up to 1100 mm (43.3") for the Z-axis.
- / Strong columns and cross beam give higher rigidity to the machine structure.
- / The machine base is designed with four box ways to support its combined sliding and rolling design. The central box ways for main support is hardened, ground and covered with Turcite-B, which features strong absorption capability, enhancing its dynamic rigidity. Moreover, the two-side box ways, which are similar to central box ways, also employ extra roller type recirculating bearings to strengthen the support. This design can evenly distribute the loading with better tolerance.
- / The table is rib-reinforced for optimum level of rigidity.
- / The Y axis utilizes a superior design with a 70 mm (2.76") offset between the lower and upper slide ways. This greatly enhances the rigidity.
- / A properly pre-loaded and pre-tensioned, large diameter ball screw is used for the three axes. The X axis has a hollow ball screw with oil cooling system and is equipped with an air cooling system for the ball screw bearings, ensuring higher positioning accuracy.
- / The mounting brackets for the Y and Z-axis ball screws are integrated with the saddle and cross beam to further maximize rigidity.
- / All three axes utilize an external feedback pulse coder for positioning. The pulse coder is coupled to the opposite end of the ball screw and sends feedback to servo system directly. This allows for high positioning accuracy.
- / Mechanical safety couplings are used where the drive motors and the ball screws get connected. These devices greatly minimize damage that may occur during a collision or an overload condition.
- / The specially designed unclamping tool cylinder totally eliminates any outside forces from being applied to the spindle bearings when releasing the tool.
- / Tool magazine is driven by a hydraulic indexing motor and the arm is rotated by a hydraulic swinging motor for stable and rapid reactions.
- / Coolant through spindle system (Optional) can clean the chips during high speed cutting in order to restrain heat.
- / The spindle head is hydraulically clamped to the curvic coupling.
- / With optional DATA SERVER and AICC II high speed processor for accurate machining.
- / With optional "Look Ahead" pre-setting function.

KMC-M



New column design increases contact surface with crossbeam and also with the ground foundation. The machine is stable because this structure.

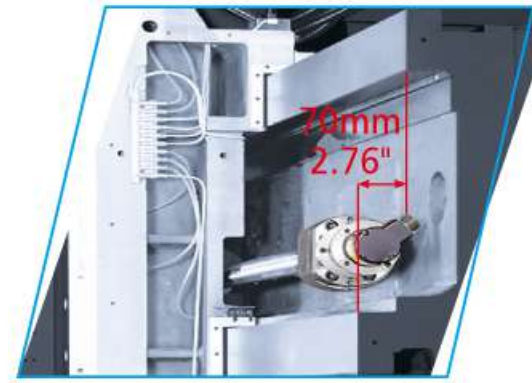

Y AXIS STEP DESIGN
The Y axis utilizes a superior design with a 70 mm (2.76") offset between the lower and upper slide ways. This greatly enhances the rigidity of the headstock by bringing the center of gravity back into the upper support, which rests on the top massive columns. This design provides an extremely stable foundation for the spindle head to travel and further enhances the machine performance when doing heavy cutting.



EXTERNAL AXIS POSITION FEEDBACK
All three axes utilize an external feedback pulse coder for positioning. For machine models over 3000m, the ball screw is driven by a motor and a gearbox with a gear ratio of 1:2 for adding strength to the axis feed system. The external position feedback pulse coder is coupled directly to the opposite end of the ball screw. This allows for high positioning accuracy by measuring the true rotation of the ball screw.



AXIS SAFETY PROTECTION
Safety couplings are used where the drive motors and the ball screws get connected. These devices greatly minimize damage that may occur during a collision or overload condition.

DOUBLE GUIDE WAY
The machine base is designed with four box ways to support its combined sliding and rolling design.



INTEGRAL BALL SCREW MOUNTING BRACKETS
The ball screws are supported by a double anchored system, which greatly improves the rigidity of the axis by minimizing vibration during feeding. The mounting brackets for the Y and Z-axis ball screws are integrated with the saddle and cross beam castings to further maximize the rigidity.

**HIGH RIGIDITY
COMBINED SLIDING AND ROLLING DESIGN**

INNER COOLING SYSTEM FOR BALL SCREWS
A properly pre-loaded and pre-tensioned, large diameter ball screw with a double recirculating ball nut is used for each axis throughout the entire machine series. For the machine models KMC-3000~KMC-5000 with the longer X-axis travels, a hollow state-of-the-art ball screw is used. Cooled oil continuously flows through the center of the ball screw. The oil temperature is cooled down, circulating through an external heat exchanger. This greatly enhances the machine performance and accuracy by practically eliminating thermal growth of the axis especially when using the full traverse. Both supporting ends of the X-axis ball screw are equipped with an air cooling system for the bearings. This superior design is unique to Kao Ming.
(For 6m & 8m models, the X-axis ball screw nut cooling system is designed to reduce thermal expansion and ensure the best positioning accuracy.)



PRECISION SCRAPING

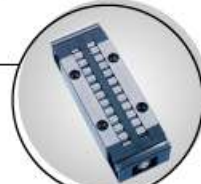

ROLLER TYPE RECIRCULATING BEARING

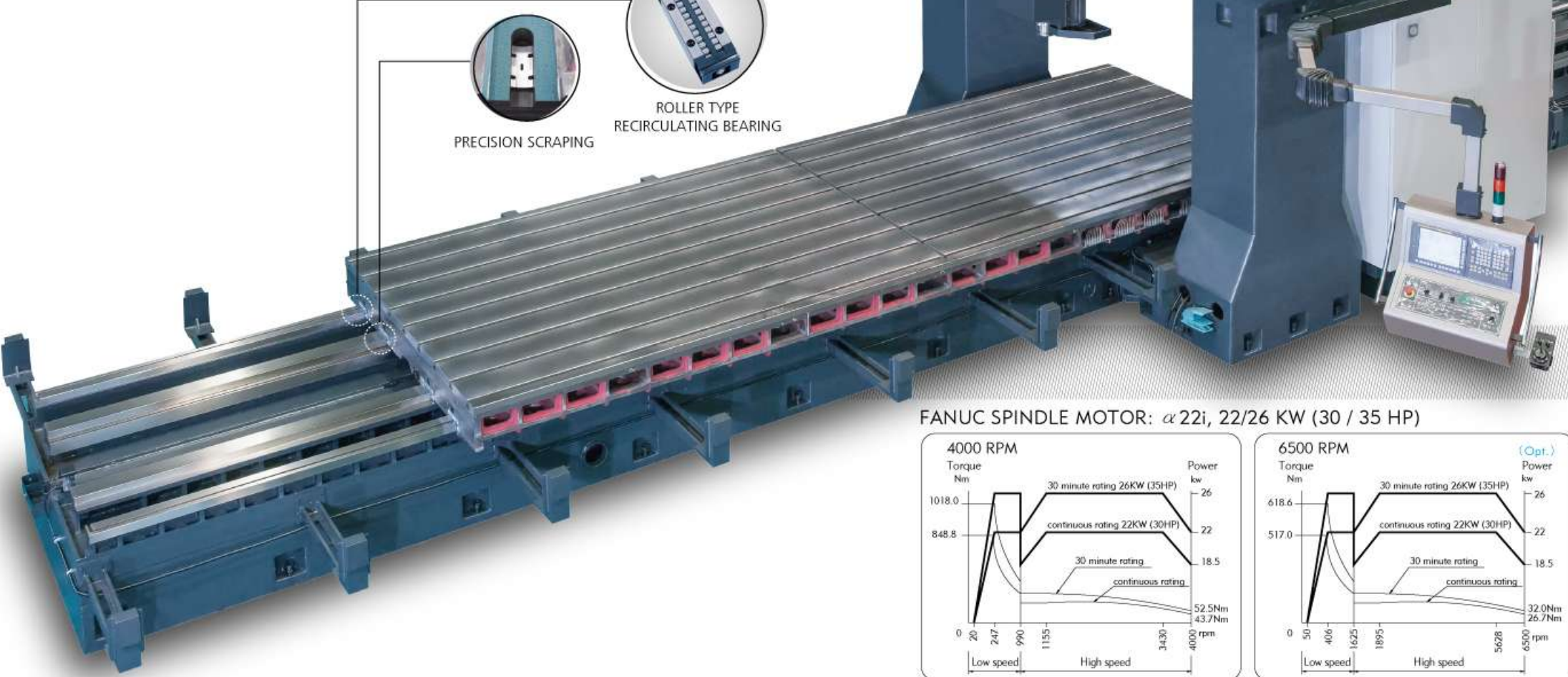

UNCLAMPING TOOL CYLINDER
The spindle also utilizes a "state-of-the-art" designed hydraulic cylinder. This special design allows the cylinder to slightly float thereby eliminating any outside forces from being applied to the spindle bearings when changing tools.

FANUC SPINDLE MOTOR: α 22i, 22/26 KW (30 / 35 HP)

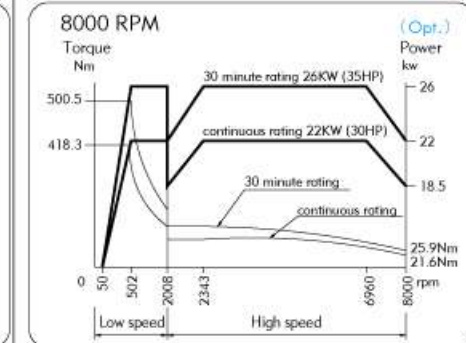
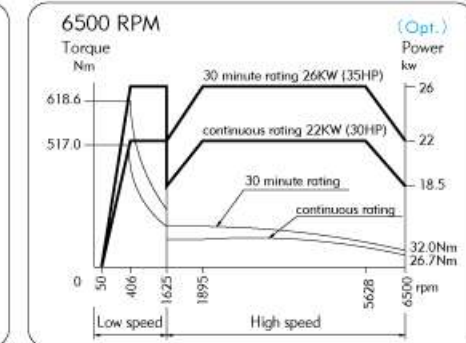
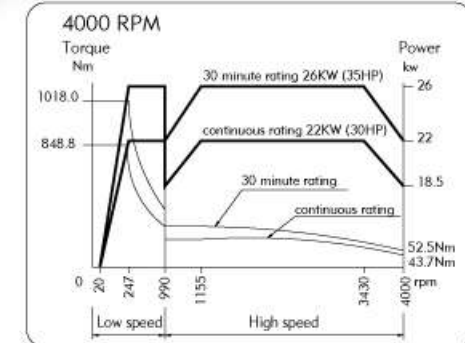

HEIDENHAIN SPINDLE MOTOR: QAN260U, 24 / 30 / 38 KW

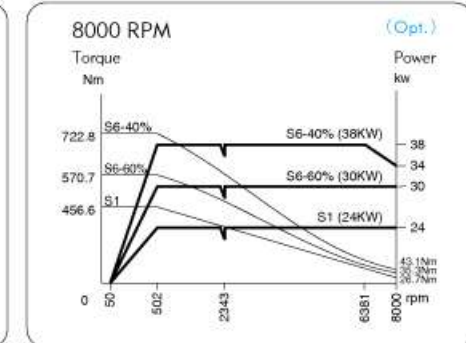
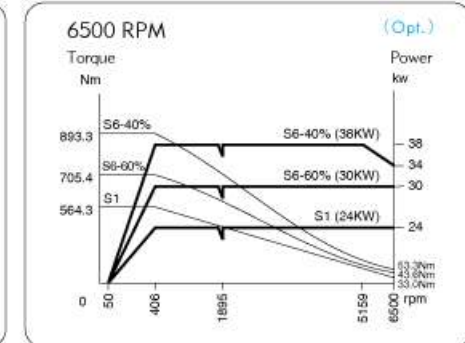
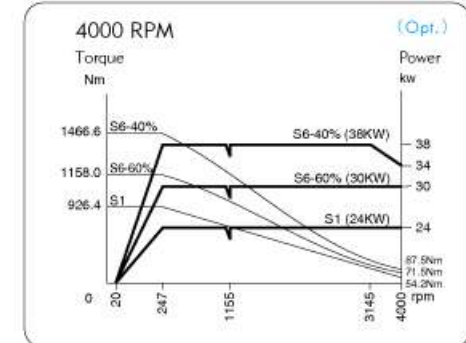

SPINDLE UNIT

	Medium Pressure	High Pressure	
Pressure (kg/cm ²)	20 (284 psi)	40 (568 psi)	70 (994 psi)
Quantity (l/min)	30 (7.92 gal/min)	30 (7.92 gal/min)	30 (7.92 gal/min)

SPINDLE OUTPUT AND TORQUE

COOLANT THROUGH SPINDLE SYSTEM

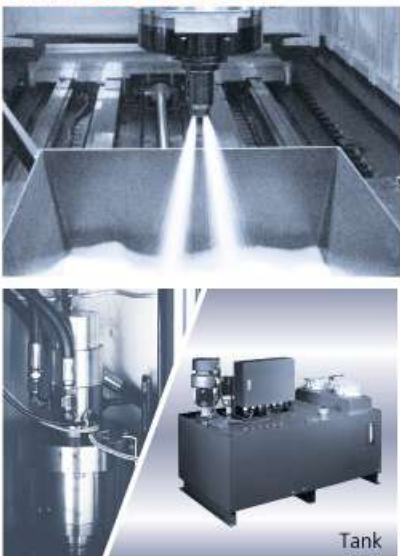

CTS (optional) comes with 600L coolant tank, high pressure pump, dual filtration and unique design for coolant hose. The system can tool effectively to minimize machining temperature and chip stuck.

HIGH EFFICIENCY ATC

POWERFUL, HIGH SPEED ATC

The standard tool magazine is equipped with 30 tool capacity, and can be upgraded to a 40, 50, 60, or 90 tool capacity. The unique double-arm tool change design, powered by a durable, high speed motor, greatly reduces tool change time to less than 6 sec. (T to T). The tool change storage and retrieval system is accomplished by a high quality, high performance, bi-directional hydraulic index motor which further enhances the ATC.



CONVENIENT TOOL LOADING SYSTEM

Tool loading and unloading can be performed at either the spindle or tool storage magazine. A foot pedal is provided at both locations allowing for easy handling of even larger tools.



CUTTING EXAMPLE (HORIZONTAL ANGULAR)

Face Mill Cutter	Ø125
Work Material	S45C
Spindle Speed (rpm)	500
Cutting Width (mm)	105 (4.13")
Cutting Depth (mm)	6 (0.23")
Feedrate (mm/min)	1300 (51.1")
Cutting Capacity (cm ³ /min)	693 (27.3")

AUTOMATIC TOOL CHANGER

- The ATC-H (Horizontal) is integrated into the original ATC-V (Vertical), which features simple construction and innovative design.
- The 2-position AAC (Automatic Attachment Changer) is designed to improve productivity.
- The angular attachment and vertical head cap are put into the AAC magazine, which has upper and lower seats and moves back and forth – separately or together. The unique design of AAC magazine can be extended with more stations for various applications.
- The automatic angular attachment can be indexed into 72 positions with 5° increment and has ±3 seconds indexing repeatability accuracy.

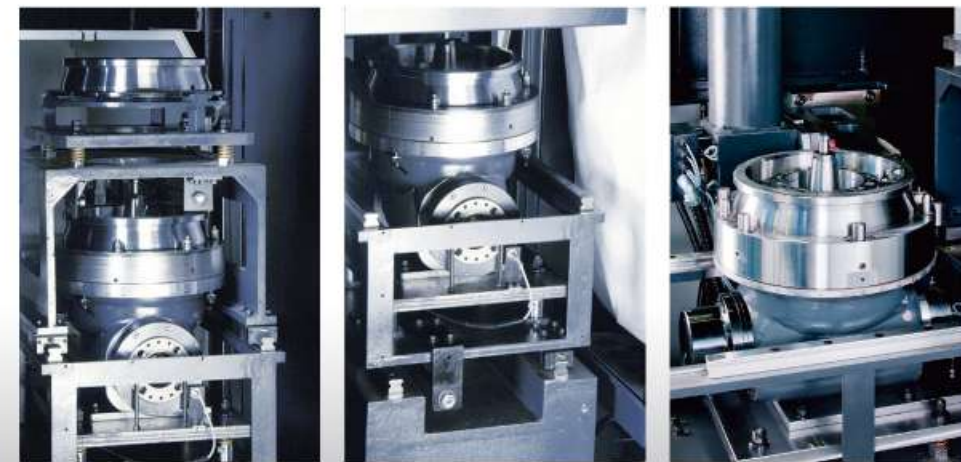

AUTOMATIC ATTACHMENT CHANGER

Standard Head



Horizontal Head

Max. Speed: 3500 rpm
Max. Power: 18.5 / 22 kw

Optional Head



Extension Head

Max. Speed: 4000 rpm
Max. Power: 22 / 26 kw

Optional Head



30° Angle Head
(Manual Tool Release)

Max. Speed: 3500 rpm
Max. Power: 18.5 / 22 kw

Optional Head



Universal Head
Max. Speed: 1500 rpm

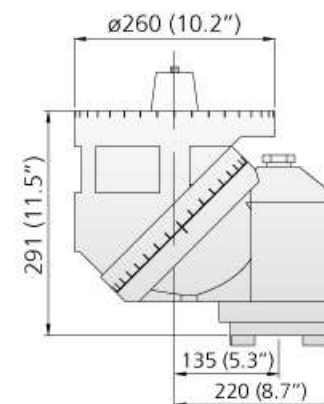
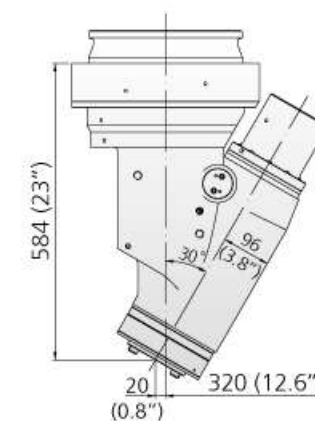
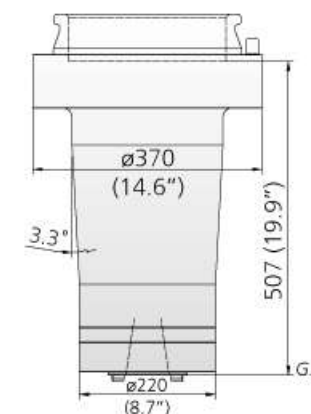
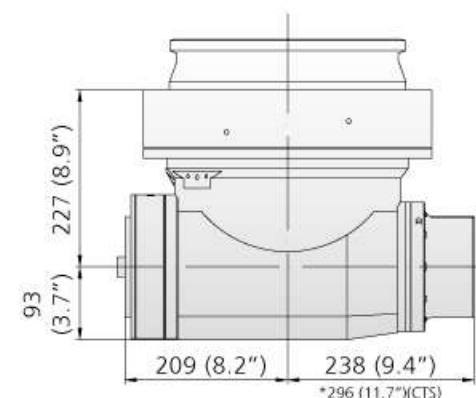

KMTCS - Kao Ming Thermal Compensation System (Optional)

KMTCS is using unique integrated techniques for the intelligent spindle cooler with thermo-compensation card and PLC software. The system is keeping the spindle at a constant temperature by program when the spindle temperature rises or falls at different working speeds. For high speed machining at fixed spindle revolution, such as for finish machining of die/mold, KMTCS is essential to offer stable and accurate performance. Moreover, in this case, it is possible to control the spindle elongation deviations within 0.02mm or even 0.01mm under specific conditions. The other thermo-compensation system PMC-M is available as option. PMC-M features an intelligent use of the shift function and the integration techniques from NC, PLC and thermo-compensation card.



COMPENSATION TEST RESULTS ON LONG-TERM PERIOD

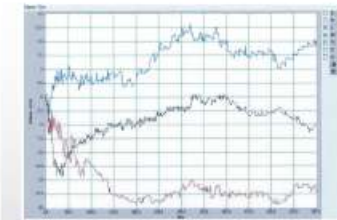

With thermal compensation system

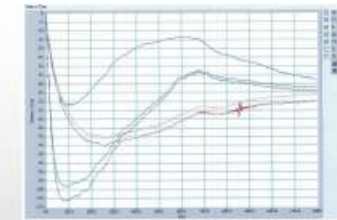

Without thermal compensation system

TABLE DIMENSIONS

Unit: mm (inch)

Distance between columns	L	A	N	P	W	T	H	K
2800 (110.2")	2400 (94.5")	100 (3.9")	11	220 (8.7")	24H8 (0.9")	42 ^{+0.15} (1.7")	42 (1.7")	18 ^{+0.2} (0.7")
3200 (126")	2600 (102.4")	100 (3.9")	13	200 (7.9")	28H8 (1.1")	46 ^{+0.15} (1.8")	52 (2.1")	20 ^{+0.2} (0.8")
3600 (141.7")	3000 (118.1")	100 (3.9")	15	200 (7.9")	28H8 (1.1")	46 ^{+0.15} (1.8")	52 (2.1")	20 ^{+0.2} (0.8")

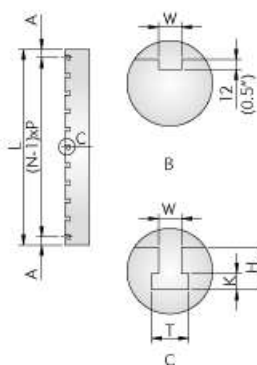
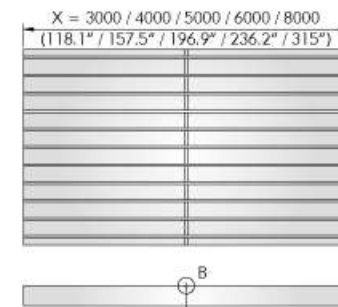

CHIP CONVEYORS SELECTION (OPTIONAL)

LINK-TYPE CHIP CONVEYORS



SCRAPER TYPE CHIP CONVEYORS (Suitable for dry chips under 60mm)



MACHINING RANGE

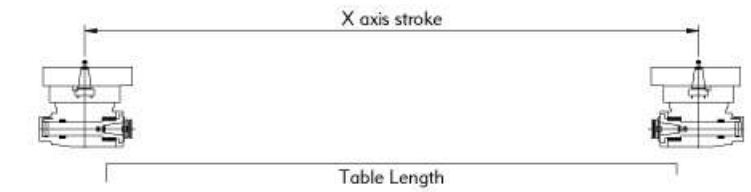
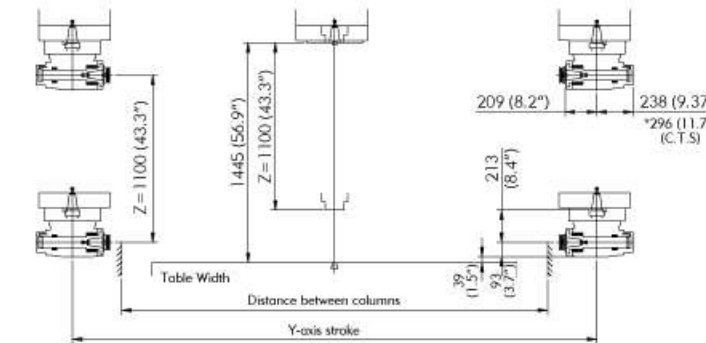

Unit: mm (inch)

Distance between columns	2800 (110.2")	3200 (126")	3600 (141.7")
Table Width	2400 (94.5")	2600 (102.4")	3000 (118.1")
Y axis stroke	3450 (135.8")	3850 (151.6")	4250 (167.3")

Unit: mm (inch)

Table length	3000 (118")	4000 (157.5")	5000 (196.9")	6000 (236.2")	8000 (315")
X axis stroke	3230 (127.2")	4230 (166.5")	5230 (205.9")	6230 (245.3")	8230 (324")

FLOOR SPACE

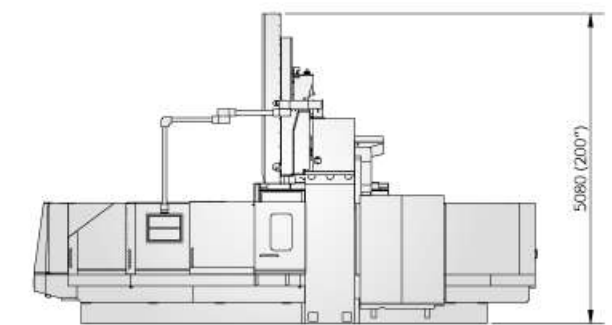
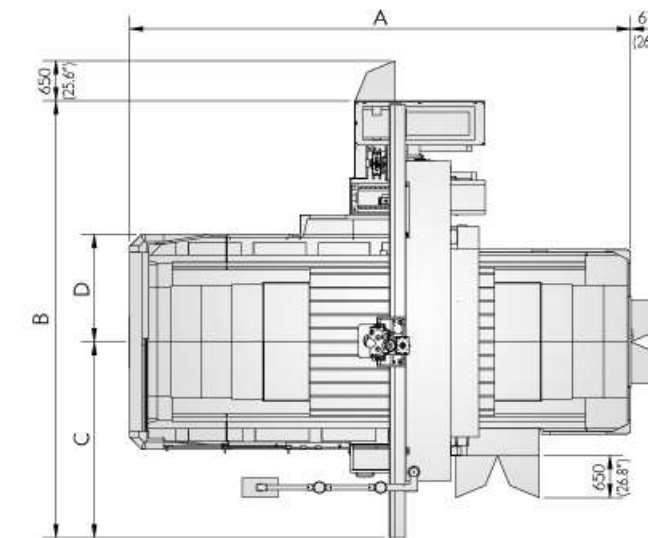

Unit: mm (inch)

	328M	332M	336M	428M	432M	436M	528M	532M	536M	628M	632M	636M	828M	832M	836M
A	8130 (320.1")			10130 (398.8")			12130 (477.6")			14330 (564.2")			19080 (751.2")		
B	7078 (278.7")	7493 (295")	7913 (311.5")	7078 (278.7")	7493 (295")	7913 (311.5")	7078 (278.7")	7493 (295")	7913 (311.5")	7078 (278.7")	7493 (295")	7913 (311.5")	7078 (278.7")	7493 (295")	7913 (311.5")
C	3175 (125")	3390 (133.5")	3610 (142.1")	3175 (125")	3390 (133.5")	3610 (142.1")	3175 (125")	3390 (133.5")	3610 (142.1")	3175 (125")	3390 (133.5")	3610 (142.1")	3175 (125")	3390 (133.5")	3610 (142.1")
D	1740 (68.5")	1940 (76.4")	2140 (84.3")	1740 (68.5")	1940 (76.4")	2140 (84.3")	1740 (68.5")	1940 (76.4")	2140 (84.3")	1740 (68.5")	1940 (76.4")	2140 (84.3")	1740 (68.5")	1940 (76.4")	2140 (84.3")

Specifications

ITEM		KMC-328M	KMC-332M	KMC-336M	KMC-428M	KMC-432M	KMC-436M	KMC-528M	KMC-532M	KMC-536M	KMC-628M	KMC-632M	KMC-636M	KMC-828M	KMC-832M	KMC-836M	
TRAVEL	Distance between columns	F G H	2800 (110.2")	3200 (126")	3600 (141.7")	2800 (110.2")	3200 (126")	3600 (141.7")	2800 (110.2")	3200 (126")	3600 (141.7")	2800 (110.2")	3200 (126")	3600 (141.7")	2800 (110.2")	3200 (126")	3600 (141.7")
	X axis (Table, longitudinal)		3230 (127.2")			4230 (166.5")			5230 (205.9")			6230 (245.3")			8230 (324")		
	Y axis (Spindle, lateral)	F G H	3450 (135.8")	3850 (151.6")	4250 (167.3")	3450 (135.8")	3850 (151.6")	4250 (167.3")	3450 (135.8")	3850 (151.6")	4250 (167.3")	3450 (135.8")	3850 (151.6")	4250 (167.3")	3450 (135.8")	3850 (151.6")	4250 (167.3")
	Z axis (Spindle, vertical)		1100 (43.3")			1100 (43.3")			1100 (43.3")			1100 (43.3")			1100 (43.3")		
	Distance from table surface to spindle nose		345 ~ 1445 (13.6" ~ 56.9")			345 ~ 1445 (13.6" ~ 56.9")			345 ~ 1445 (13.6" ~ 56.9")			345 ~ 1445 (13.6" ~ 56.9")			345 ~ 1445 (13.6" ~ 56.9")		
	Distance from table surface to horizontal spindle center		132 ~ 1232 (5.2" ~ 48.5")			132 ~ 1232 (5.2" ~ 48.5")			132 ~ 1232 (5.2" ~ 48.5")			132 ~ 1232 (5.2" ~ 48.5")			132 ~ 1232 (5.2" ~ 48.5")		
TABLE	Table working surface	F G H	2400 x 3000 (94.5" x 118.1")	2600 x 3000 (102.4" x 118.1")	3000 x 3000 (118.1" x 118.1")	2400 x 4000 (94.5" x 157.5")	2600 x 4000 (102.4" x 157.5")	3000 x 4000 (118.1" x 157.5")	2400 x 5000 (94.5" x 196.9")	2600 x 5000 (102.4" x 196.9")	3000 x 5000 (118.1" x 196.9")	2400 x 6000 (94.5" x 236.2")	2600 x 6000 (102.4" x 236.2")	3000 x 6000 (118.1" x 236.2")	2400 x 8000 (94.5" x 315")	2600 x 8000 (102.4" x 315")	3000 x 8000 (118.1" x 315")
	Table configuration	F G H	24 ^{H8} mm x 11 x 220 mm (0.94" x 11 x 8.66")	28 ^{H8} mm x 13 x 200 mm (1.1" x 13 x 7.87")	28 ^{H8} mm x 15 x 200 mm (1.1" x 15 x 7.87")	24 ^{H8} mm x 11 x 220 mm (0.94" x 11 x 8.66")	28 ^{H8} mm x 13 x 200 mm (1.1" x 13 x 7.87")	28 ^{H8} mm x 15 x 200 mm (1.1" x 15 x 7.87")	24 ^{H8} mm x 11 x 220 mm (0.94" x 11 x 8.66")	28 ^{H8} mm x 13 x 200 mm (1.1" x 13 x 7.87")	28 ^{H8} mm x 15 x 200 mm (1.1" x 15 x 7.87")	24 ^{H8} mm x 11 x 220 mm (0.94" x 11 x 8.66")	28 ^{H8} mm x 13 x 200 mm (1.1" x 13 x 7.87")	28 ^{H8} mm x 15 x 200 mm (1.1" x 15 x 7.87")	24 ^{H8} mm x 11 x 220 mm (0.94" x 11 x 8.66")	28 ^{H8} mm x 13 x 200 mm (1.1" x 13 x 7.87")	28 ^{H8} mm x 15 x 200 mm (1.1" x 15 x 7.87")
	Max. table load		12000 kg (24600 lb) / *18000 (39600 lb) kg			13000 kg (28600 lb) / *20000 kg (44000 lb)			14000 kg (30800 lb) / *22000 kg (48400 lb)			15000 kg (33000 lb) / *25000 kg (55000 lb)			22000 kg (48400 lb) / *25000 kg (55000 lb)		
SPINDLE	Spindle speed	Vertical	4000 (*6500, *8000) rpm			4000 (*6500, *8000) rpm			4000 (*6500, *8000) rpm			4000 (*6500, *8000) rpm			4000 (*6500, *8000) rpm		
		Horizontal	3500 rpm			3500 rpm			3500 rpm			3500 rpm			3500 rpm		
	No. of spindle speed	Infinite variable, two steps			Infinite variable, two steps			Infinite variable, two steps			Infinite variable, two steps			Infinite variable, two steps			
	Spindle taper	ISO 50			ISO 50			ISO 50			ISO 50			ISO 50			
	Spindle motor (Cont./30min)	AC 22/26 kw (30/35 HP)			AC 22/26 kw (30/35 HP)			AC 22/26 kw (30/35 HP)			AC 22/26 kw (30/35 HP)			AC 22/26 kw (30/35HP)			
Max. spindle torque	1018 Nm (104 kg-m)			1018 Nm (104 kg-m)			1018 Nm (104 kg-m)			1018 Nm (104 kg-m)			1018 Nm (104 kg-m)				
FEED RATE	Rapid traverse (X, Y, Z)		(12,12,10) m/min (472,472,393) ipm	(12,10,10) m/min (472,393,393) ipm	(12,8,10) m/min (472,315,393) ipm	(10,12,10) m/min (393,472,393) ipm	(10,10,10) m/min (393,393,393) ipm	(10,8,10) m/min (393,315,393) ipm	(8,12,10) m/min (315,472,393) ipm	(8,10,10) m/min (315,393,393) ipm	(8,8,10) m/min (315,315,393) ipm	(7,12,10) m/min (276,472,393) ipm	(7,10,10) m/min (276,393,393) ipm	(7,8,10) m/min (276,315,393) ipm	(7,12,10) m/min (276,472,393) ipm	(7,10,10) m/min (276,393,393) ipm	(7,8,10) m/min (276,315,393) ipm
	Cutting feed rate		1 ~ 5000 mm/min (0.1 ~ 196 ipm)			1 ~ 5000 mm/min (0.1 ~ 196 ipm)			1 ~ 5000 mm/min (0.1 ~ 196 ipm)			1 ~ 5000 mm/min (0.1 ~ 196 ipm)			1 ~ 5000 mm/min (0.1 ~ 196 ipm)		
AUTOMATIC TOOL CHANGER (V/H)	Tool shank shape		MAS403-BT50			MAS403-BT50			MAS403-BT50			MAS403-BT50			MAS403-BT50		
	Pull stud		MAS-P50T-1			MAS-P50T-1			MAS-P50T-1			MAS-P50T-1			MAS-P50T-1		
	Tool magazine capacity		30 (*40, *50, *60, *90) tools			30 (*40, *50, *60, *90) tools			30 (*40, *50, *60, *90) tools			30 (*40, *50, *60, *90) tools			30 (*40, *50, *60, *90) tools		
	Max. tool diameter (Without adjacent tools)		ø130, ((ø200)) [ø5.7", ((ø7.87"))]			ø130, ((ø200)) [ø5.7", ((ø7.87"))]			ø130, ((ø200)) [ø5.7", ((ø7.87"))]			ø130, ((ø200)) [ø5.7", ((ø7.87"))]			ø130, ((ø200)) [ø5.7", ((ø7.87"))]		
	Max. tool length (V/H)		350 (13.8") / 300 (11.8")			350 (13.8") / 300 (11.8")			350 (13.8") / 300 (11.8")			350 (13.8") / 300 (11.8")			350 (13.8") / 300 (11.8")		
Max. tool weight (V/H)		20 kg (44 lb) / 15 kg (33 lb)			20 kg (44 lb) / 15 kg (33 lb)			20 kg (44 lb) / 15 kg (33 lb)			20 kg (44 lb) / 15 kg (33 lb)			20 kg (44 lb) / 15 kg (33 lb)			
POWER SOURCE	Electrical power supply		70 KVA			70 KVA			70 KVA			70 KVA			70 KVA		
	Compressed air supply		5 ~ 7 kg/cm ² (70 ~ 98 psi)			5 ~ 7 kg/cm ² (70 ~ 98 psi)			5 ~ 7 kg/cm ² (70 ~ 98 psi)			5 ~ 7 kg/cm ² (70 ~ 98 psi)			5 ~ 7 kg/cm ² (70 ~ 98 psi)		
ACCURACY	Positioning accuracy		±0.005 / 300 (±0.0002" / 12")			±0.005 / 300 (±0.0002" / 12")			±0.005 / 300 (±0.0002" / 12")			±0.005 / 300 (±0.0002" / 12")			±0.005 / 300 (±0.0002" / 12")		
	Repeatability		±0.003 (±0.0001")			±0.003 (±0.0001")			±0.003 (±0.0001")			±0.003 (±0.0001")			±0.003 (±0.0001")		
ANGULAR ATTACHMENT	Indexing		90° x 4 (*5° x 72)			90° x 4 (*5° x 72)			90° x 4 (*5° x 72)			90° x 4 (*5° x 72)			90° x 4 (*5° x 72)		
	Indexing repeatability		±3 sec			±3 sec			±3 sec			±3 sec			±3 sec		
MACHINE SIZE	Machine height		5080 (200")			5080 (200")			5080 (200")			5080 (200")			5080 (200")		
	Floor space	F G H	8130 x 7078 (320.1" x 278.7")	8130 x 7493 (320.1" x 295")	8130 x 7913 (320.1" x 311.5")	10130 x 7078 (398.8" x 278.7")	10130 x 7493 (398.8" x 295")	10130 x 7913 (398.8" x 311.5")	12130 x 7078 (477.6" x 278.7")	12130 x 7493 (477.6" x 295")	12130 x 7913 (477.6" x 311.5")	14330 x 7078 (564.2" x 278.7")	14330 x 7493 (564.2" x 295")	14330 x 7913 (564.2" x 311.5")	19080 x 7078 (751.2" x 278.7")	19080 x 7493 (751.2" x 295")	19080 x 7913 (751.2" x 311.5")
	Machine net weight	F G H	42000 kg (92400 lb)	44000 kg (96800 lb)	48000 kg (105600 lb)	46800 kg (102960 lb)	48300 kg (106260 lb)	54000 kg (118800 lb)	51500 kg (113300 lb)	53000 kg (116600 lb)	60000 kg (132000 lb)	56000 kg (123200 lb)	57800 kg (127160 lb)	66000 kg (145200 lb)	73000 kg (160600 lb)	80000 kg (176000 lb)	85000 kg (187000 lb)

CNC CONTROLLER FANUC SERIES, (*SIEMENS), (*HEIDENHAIN)

Unit: mm (inch)

* Option: Design specifications are subject to change without prior notice. (()) Max. tool diameter (without adjacent tools) Distance between two columns F=2800 mm, G=3200 mm, H=3600 mm

STANDARD ACCESSORIES

- Ⓜ Coolant equipment
- Ⓜ Centralized automatic lubrication system
- Ⓜ Rigid tapping
- Ⓜ Splash guard
- Ⓜ Adjusting tools and box (1set)
- Ⓜ Manual and electrical drawing (1set)
- Ⓜ Leveling and foundation fittings
- Ⓜ Work light
- Ⓜ Spindle cooling system (Chiller unit)
- Ⓜ Alarm lamp
- Ⓜ Air blast
- Ⓜ Automatic power off
- Ⓜ Operation finish lamp
- Ⓜ Screw type chip conveyor
- Ⓜ Transformer (Except for 220V)
- Ⓜ Inner Cooled Ballscrew
- Ⓜ Slideway Covers
- Ⓜ Magazine Safety Guard
- Ⓜ Electrical Cabinet Light
- Ⓜ Manual Tool Change and Foot Switch
- Ⓜ Reinforced Foot-Stand at Both Table-End
- Ⓜ Electrical Cabinet Cooling System (Air Conditioner)

OPTIONAL ACCESSORIES

- Ⓜ Chip conveyor (Link type or Scraper type)
- Ⓜ Mist coolant unit
- Ⓜ NC rotary table
- Ⓜ CAT50, DIN50, ISO50, HSK-A100 tool shank
- Ⓜ Oil hole drill interface
- Ⓜ Linear scale feedback system
- Ⓜ Automatic tool length measuring system
- Ⓜ Automatic touch probe centering system
- Ⓜ Coolant through spindle system (A, B type)
- Ⓜ KMTCS - Kao Ming thermal compensation system
- Ⓜ Larger Capacity Coolant Tank
- Ⓜ Fully Enclosed Splash Guard
- Ⓜ Coolant Purifying System
- Ⓜ Coolant Cooling System
- Ⓜ Paper(Belt)filter System
- Ⓜ Hydraulic Cooling System
- Ⓜ Electrical Cabinet Cooling System (Up to 45°C Capacity)
- Ⓜ Specified Sub Table, T-slot, Machine Color
- Ⓜ Extra Load Capacity
- Ⓜ Anchoring Alignment System
- Ⓜ Three or four-station AAC system
- Ⓜ Universal Head
- Ⓜ 30° Angle Head



KAO MING MACHINERY INDUSTRIAL CO., LTD.

<http://www.kaoming.com>



HEAD OFFICE

No.861, Sanfong Rd., Fongyuan District, Taichung City, 42073 Taiwan.

CTSP

No.53, Houke S. Rd., Houli District, Taichung City, 42152 Taiwan.

TEL: +886-4-25577650 FAX: +886-4-25577630

E-MAIL: km@kaoming.com.tw



KM Web

Cat.23 1510(E)X1000B



DOUBLE COLUMN MULTI CENTER

KAO MING MACHINERY INDUSTRIAL CO., LTD.