



HIGH-TECH OF KAO MING

POWER FOR TOMORROW

"I have a dream that one day the rough places will be made plain, and the crooked places will be made straight," Martin Luther King, Jr. said. Foresighted industrial innovation is always based on the constructive thinking of "dare to dream."

Kao Ming Machinery Industrial Co., LTD. perseveres in its efforts with innovative and revolutionary ideas to develop advanced technology and professional products in the related industrial field. Nowadays, it is the very moment for advanced industry to improve human beings' lives through all who dare to dream. Let's take the opportunity to succeed with Kao Ming.

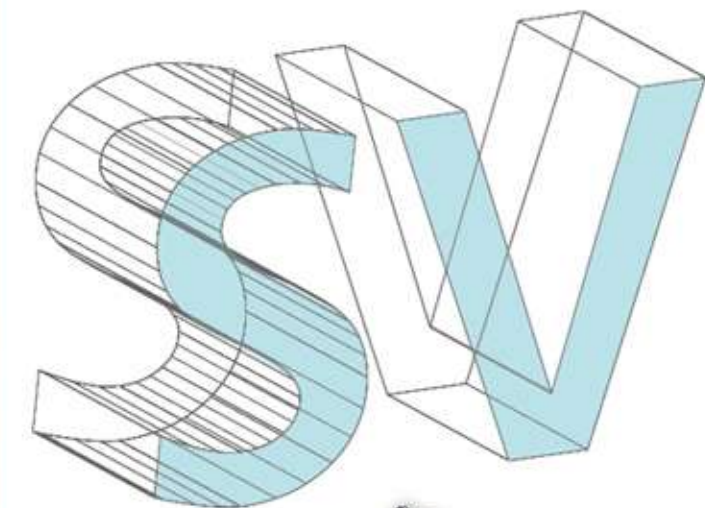

KMC-SV Series
 2000SV
 3000SV
 4000SV
 5000SV
 6000SV
 8000SV
 (with various options)



- / SV exterior appearance: Arc modeling in front
- / Z axis stroke: 850 mm
- / Spindle nose: Extended Spindle
- / Workpieces: Mid-sided / Large-scale / Deep hole & Concave slot machining



MACHINE FEATURES

- / SV series is designed from the SD series with 33.5" (850 mm) Z axis travel to accommodate taller parts.
- / The X, Y & Z axis are fully support by rigid box ways.
- / All models with the longer distances between the columns, utilize a total of 4 box ways on the X axis for enhanced rigidity.
- / The table never travels overhang hereby ensuring the rigidity throughout the entire travel of all axes.
- / The Y axis utilizes a superior design where by the lower slideway is offset a full 2.76" (70 mm) forward from the upper slideway. This greatly enhances the rigidity of the headstock by bringing the center of gravity back into the upper support.
- / Only a distance of 3.35" (85 mm) from spindle center to Z axis slideway
- / Two gear ranges, helical and spur gears support the spindle transmission system for machining large cavities at low RPM.
- / Extended spindle (SD Series opt.) is standard accessories (SV Series) that applies to deep hole drilling and concave milling.



Yesterday's Honor Today Leaps

TWO GUIDEWAY BASE



Precision Scraping

The superior, hardened, ground double guide way constructed bed is designed for a distance between columns of under 82". A total of four box ways are utilized for the models with a distance between columns of over 82". All surfaces that make contact with the slideways are lined with Turcite B to ensure long lasting and optimum rigidity during heavy cutting conditions. Precision scraping of the Turcite B surface ensures smooth axis traverse without stick-slip movements, to further enhance the machine's overall rigidity and reliability.

Double guide way base has wide and narrow two types.
Wide type: 64.9" (1650mm) table width w/ 41.7" (1060mm) distance between two guide ways.
Narrow type: 49.2" (1250mm) table width w/ 31.5" (800mm) distance between two guide ways.
Design concept is making sure the right distance between two guide ways fully support the table. This will also maximize movement rigidity and precision with heavy table load.

FOUR GUIDEWAY BASE



Precision scraping

Large piece parts machining will require heavy loading capacity, so from "D" model and up (distance between two columns 90.55" (2300 mm)), machine base equips four box way to support-in a combined designed of slide rolling. Center box way for main support is hardened and ground, with Turcite-B which has stronger absorb ability to keep dynamic rigidity during heavy cutting. And 2 sides box way the same as center only have extra roller-type recirculating bearing to strengthen support. This design can minimize loading pressure during movement and increase efficient. The tables 2 end-front and rear of sliding surface also equips roller-type recirculating bearing to make precision adjustment for the geometry accuracy. To assembly with recirculating bearing, hardness of box way surface must be more than HRC58". Therefore we make box way either tightened on the casting base or welded on the fabricated base.



Roller-type recirculating bearing



HIGHLY RIGID BOX WAY CONSTRUCTION



The double column and closed style construction, with all three axes fully supported, minimizes the displacement brought on by the load of the work piece and heavy cutting forces.



The heavy duty box way is construction with Meehanite cast iron and is designed and inspected by FEA (Finite Element Analysis) to ensure excellent rigidity. This will extend machine life even under both high speed and heavy duty machining.

COLUMN AND CROSSBEAM

Both columns and crossbeam are also constructed with Meehanite cast iron undergoing annealing process. This reliefs the internal stress and ensure no displacement. Therefore, the spindle headstock has stronger support and also maintain great perpendicular geometric accuracy in all axes.

TABLE

Cast iron table with density rib is the best structure to avoid bending, twist stress, and reduce deform possibility. This ensures 3 axes tolerance accuracy in this datum plane.

APPLICABLE INDUSTRIES



SD - Fully enclosed splash guard (Opt.)



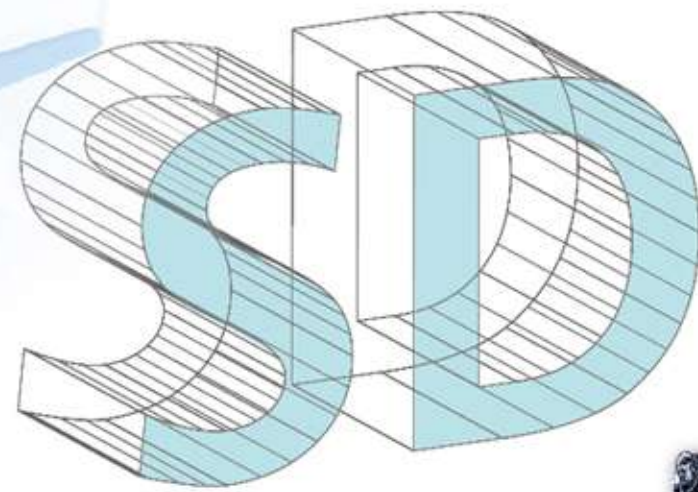

KMC-SD Series
 2000SD
 3000SD
 4000SD
 5000SD
 6000SD
 8000SD
 (with various options)



- / SD exterior appearance: Rectangle modeling in front
- / Z axis stroke: 700 mm
- / Spindle nose: Flush Spindle
- / Workpieces: Middle-sized / Large-scale / Deep hole & Doncave slot machining

- / The spindle utilizes a "state of the art" designed hydraulic tool unclamp cylinder. This special design totally eliminates any outside forces from being applied to the spindle bearings when releasing the tool.
- / Oil cooled X axis hollow ballscrew (Model: 2000 mm ~ 5000 mm).
- / Air cooled X axis ballscrew nut for minimum thermal elongation and the best of position accuracy (Model: 6000 mm ~ 8000 mm).
- / ATC system is driven with hydraulic indexing motor and dual arm is driven with hydraulic swing motor. This answers tool change speed and stability.
- / Coolant through spindle system (option) can flush chips during high speed machining and restrain heat.

HIGH RIGIDITY STRUCTURE

HIGH POSITIONING ACCURACY

The Y axis utilizes a superior design whereby the lower slideway is offset a full 2.76" [70 mm] from the upper slideway. This greatly enhances the rigidity of the head-stock by bringing the center of gravity back into the upper support which rests atop the massive columns. This design provides an extremely stable foundation for the spindle head to travel on further enhancing the machine's performance when doing heavy cutting.

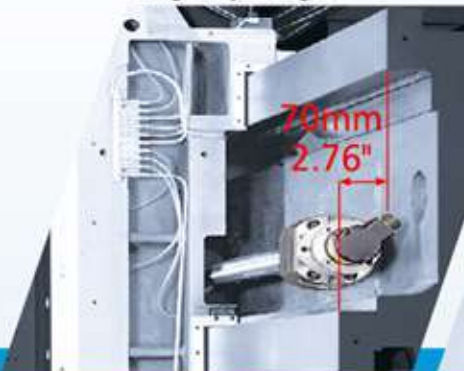

Y AXIS STEP DESIGN

This distance is only 3.3", which is the smallest in the industry. This efficient design provides a much more stable headstock by minimizing the amount of cantilever from the slideways. This design also greatly decreases the amount of heat displacement that can be associated with the rise of spindle temperature, which further increases the machine accuracy.



MINIMAL DISTANCE FROM SPINDLE CENTER LINE TO Z-AXIS SLIDEWAY

A properly preloaded and pretension, large diameter ballscrew with a double re-circulating ball nut is used for each axis throughout the entire machine series. For the machine models KMC-3000-KMC-6000 with the longer X axis travels, a hollow state-of-the-art ballscrew is used. Cooled oil continuously flows through the center of the ballscrew. The temperature of all the oil is cooled, circulating through an external heat exchanger. This greatly enhances the machine's performance and accuracy by practically eliminating thermal growth of the axis especially when using the full traverse. Both support ends of the X axis ballscrew are equipped with a special design to cool the bearings by air. This superior design is unique to Kao Ming.

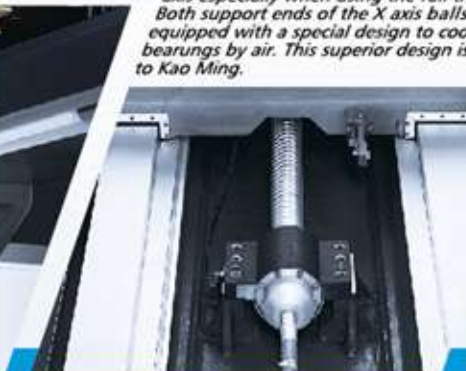

INNER COOLED BALLSCREW

For the machine models KMC-5000-KMC-8000 with the longer X axis travels, there is a special mechanism (Std.) to balance the gravity weight of the ballscrew and to get better performance of the system.



BALLSCREW SUPPORT MECHANISM

All 3 axes utilize an external feedback pulse coder for positioning. For machine models 2000SV / SD-A, B&C, the X axis position feedback system is directly driven, with the servo motor coupled directly to the ballscrew. For machine models over 3000SV/SD, the ballscrew is driven by a motor and gear box with a gear ratio of 1:2 for added strength to the axis feed system. The external position feedback pulse coder is coupled directly to the opposite end of the ballscrew. This allows for high positioning accuracy to be maintained by measuring the true rotation of the ballscrew.



EXTERNAL AXIS POSITION FEEDBACK

The ballscrew are supported by a double anchor system, which greatly improves the rigidity of the axis by minimizing vibration during feeding. The mounting brackets for the Y and Z axis ballscrews are integrated with the saddle and crossbeam castings to maximize the rigidity further.



INTEGRAL BALLSCREW MOUNTING BRACKETS

Safety couplings are used where the drive motors adapt to the ballscrew. These devices greatly minimize damage that many occur during a collision or overload condition.



AXIS SAFETY PROTECTION

PRECISE SCRAPING

Kao Ming machines feature outstanding geometric accuracy, which not only results from precision machining on structural parts, but also relies on our state-of-the-art scraping techniques. Our highly skilled scraping technicians have rich experiences with their meticulous working attitude to achieve the optimal perpendicularity, parallelism, flatness and moving smoothness. During scraping process, sophisticated inspection instruments are also applied for calibrating the machine's geometric accuracy to the best condition.





RIGID POWERFUL SPINDLE HEAD

The spindle transmission incorporates both helical and spur gears for driving the spindle. Therefore, even at 6 rpm, the machine can easily perform boring large diameter holes. The "SV" series spindle is supported by a total of 5 precision class (P4) angular contact bearings. The "SD" series spindle is supported by 4 precision class (P4) angular contact bearings. Both designs are enclosed with grease lubricant. The entire spindle and transmission units are cooled by a contact circulation of oil in order to maintain a constant operational temperature. The headstock assembly is counter balanced by a single hydraulic cylinder. This answers smooth movement of z-axis.

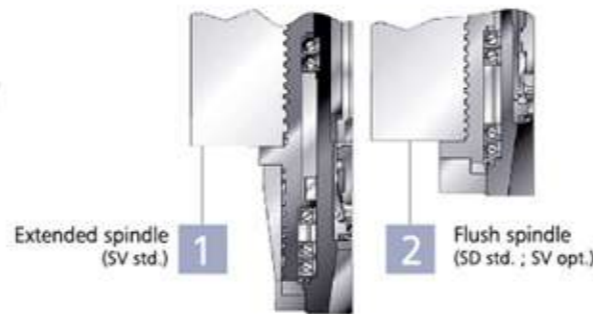

- / Powerful spindle motor and high torque output spindle on BT-50 taper machines.
- / High-grade materials: Spindle, gears, splines, etc., are CNC machined and out of alloy steel hardened and ground.
- / High precision spindle bearings: ISO class P4 quality.
- / 2 Step gear transmission: Spindle provides high torque output at low rpm for heavy-duty machining.

SV/SD SPINDLE NOSE SELECTION

SD	STD.	OPT.
SV	OPT.	STD.

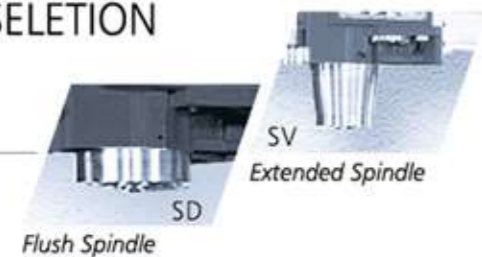

FLOATING TYPE TOOL CHANGE CYLINDER

The spindle also utilizes a "state-of-the-art" designed hydraulic cylinder. This special design allows the cylinder to slightly float thereby eliminating any outside forces from being applied to the spindle bearings when changing tools.

SPINDLE OUTPUT AND TORQUE (FANUC Spindle motor)

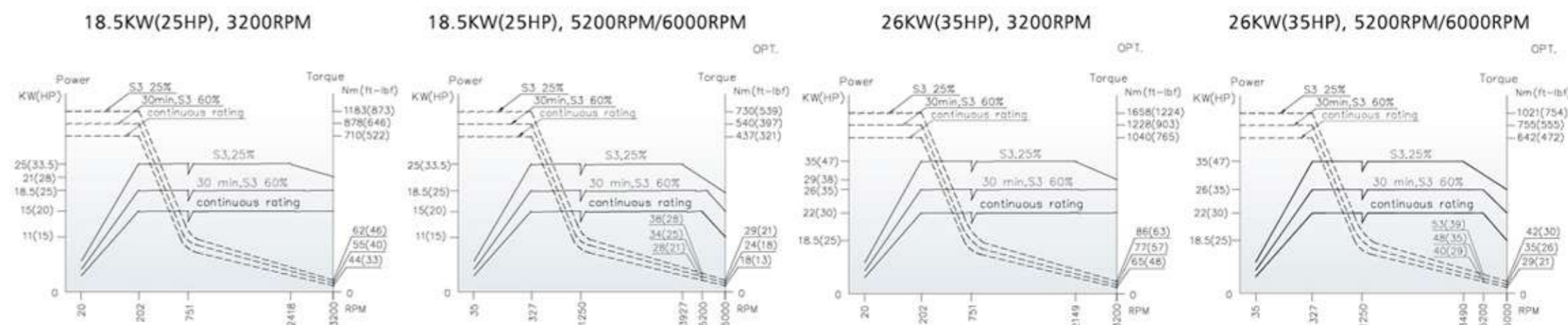

OUTSTANDING CUTTING CAPACITY

1099 c.c / min (S45c)

Spindle Motor: 30HP / 35HP

FACE MILLING

Tool: ø125mm Cutting Width: 90mm Spindle Speed: 650rpm Feedrate: 2444mm/min Cutting Depth: 5mm Cutting Capacity: 1099 c.c/min Material: S45C
 Tool: ø125mm Cutting Width: 100mm Spindle Speed: 550rpm Feedrate: 1400mm/min Cutting Depth: 5.5mm Cutting Capacity: 770 c.c/min Material: Mold steel(Hardness HRC 32°)

DRILLING

KUB KUB Rapid Drill: ø88mm Spindle Speed: 360rpm Feedrate: 54mm/min Cutting Depth: 328c.c/min Material: KTSN3A (Plastic mold steel, HardnessHRC28°)

End Milling

End Milling Tool: ø50mm Spindle Speed: 777rpm Feedrate: 390mm/min Cutting Depth: 35mm Cutting Depth: 682c.c/min Material: S45C

Tapping

Tapping Tool: M52xP5 Spindle Speed: 50rpm Feedrate: 250mm/min Material: S45C

OPTIONALLY AVAILABLE



Angle Head (Opt.)



Universal Head (Opt.)

Unit: mm(inch)

CUTTING CAPACITY EXAMPLE

Spindle Motor: 20HP / 25HP

	Tool	Workpiece Material	Spindle Speed	Cutting Width	Cutting Depth	Feedrate	Cutting Capacity
Angle Head	Face Milling ø125 mm (5")	S45C (1045)	500 rpm	90 mm (3.54")	5 mm (0.2")	825 mm/min (32.4 ipm)	371 cc/min (22.6 cu.in/min)
Universal Head			350 rpm	80 mm (3.15")	-	1200 mm/min (47.2ipm)	480 cc/min (29.2 cu.in/min)
Angle Head	Drilling ø55 mm (2")		150 rpm	-	-	40 mm/min (32.4ipm)	-
Universal Head			120 rpm	-	-	42 mm/min (1.65ipm)	-

MACHINING RANGE / MANUAL ANGLE HEAD

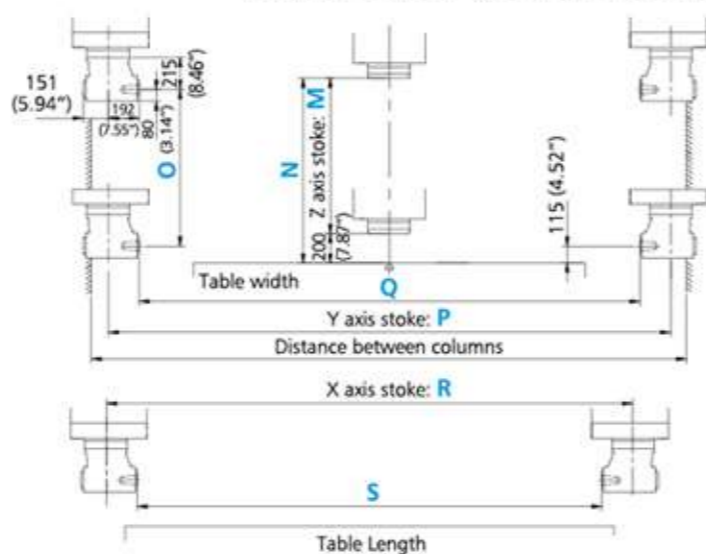

Model	Size	M	N	O	P	Q	R	S
SD	Z Axis Stroke	900 (35.43")	570 (22.44")	Y Axis Stroke	Y Axis Stroke-384	X Axis Stoke	X Axis Stoke-384	
SV	Z Axis Stroke	1050 (41.33")	720 / *850 (28.34" / *33.46")	Y Axis Stroke	Y Axis Stroke-384	X Axis Stoke	X Axis Stoke-384	

HIGH EFFICIENCY ATC



POWERFUL, HIGH SPEED ATC

The standard tool magazine is equipped with 30 tool capacity, and can be upgraded to a 40, 50, 60, or 90 tool capacity. The unique double-arm tool change design, powered by a durable, high speed motor, greatly reduces tool change time to less than 6 sec. (T to T). The tool change storage and retrieval system is accomplished by a high quality, high performance, bi-directional hydraulic index motor which further enhances the ATC.

AUTOMATIC TOOL MAGAZINE DOOR

The tooling within the magazine is well protected from chips, coolant, and other debris by a fully programmable door. The door operates in conjunction with the ATC, eliminating the need to program it separately.

CONVENIENT TOOL LOADING SYSTEM

Tool loading and unloading can be performed at either the spindle or tool storage magazine. A foot pedal is provided at both locations allowing for easy handling of even larger tools.

INSPECTION & ACCURACY

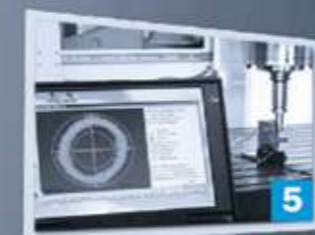

- 1 Thermal Compensation Test
- 2 Straightness Measurement
- 3 Laser Positioning Accuracy Inspection
- 4 Kinematic Measurement
- 5 Dynamic Spindle Running Accuracy Test
- 6 Geometric Accuracy Inspection
- 7 Rigidity Test



CHIP CONVEYORS SELECTION (OPTIONAL)

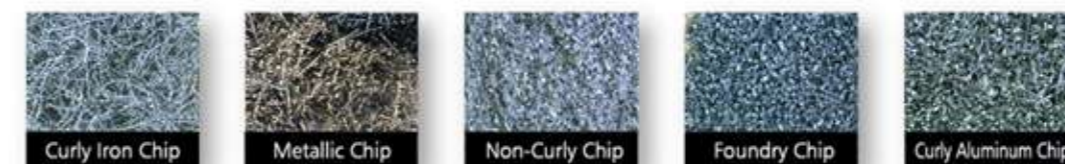

STEELBELT CHIP CONVEYORS



SCRAPER TYPE CHIP CONVEYORS (Suitable for dry chips under 60mm)

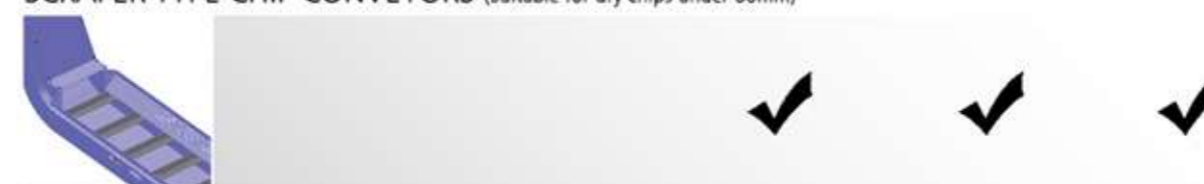

COOLANT THROUGH SPINDLE SYSTEM

CTS (optional) comes with 600L coolant tank, high pressure pump, dual filtration and unique design for coolant hose. The system can tooling effectively to minimize machining temperature and chip stuck.

	Medium Pressure	High Pressure	
Pressure (kg/cm ²)	20 (284psi)	40 (568psi)	70 (994psi)
Quantity (l/min)	30(7.92gal/min)	30(7.92gal/min)	30(7.92gal/min)



STANDARD ACCESSORIES

1. Coolant Equipment
2. Centralized Automatic Lubrication System
3. Rigid Tapping
4. Splash Guard
5. Adjusting Tools And Box (1Set)
6. Manual And Electrical Drawing (1Set)
7. Leveling And Foundation Fittings
8. Work Light
9. Spindle Cooling System (Chiller Unit)
10. Alarm Lamp
11. Air Blast
12. Automatic Power Off
13. Operation Finish Lamp
14. Screw-type Chip Conveyor
15. Transformer (Except 220v)
16. Inner Cooled Ballscrew
17. Slideway Covers
18. Magazine Safety Guard
19. Electrical Cabinet Light
20. Manual Tool Change and Foot Switch
21. Reinforced Foot-Stand at Both Table-End
22. Electrical Cabinet Cooling System (Air Conditioner)

OPTIONAL ACCESSORIES

1. Chip Conveyor
2. Mist Coolant Unit
3. NC Rotary Table
4. Angle Head (Manual)
5. Universal Head (Manual)
6. Oil Hole Drills Interface
7. Linear Scale Feedback System
8. Automatic Tool Length Measuring System
9. Automatic Touch Probe Centering System
10. Coolant Through Spindle System (A,B Type)
11. CAT50, DIN50, ISO50 Tool Shank
12. KMTCS-Kao Ming Thermal Compensation System
13. Larger Capacity Coolant Tank
14. Anchoring Alignment System
15. Fully Enclosed Splash Guard
16. Coolant Purifying System
17. Coolant Cooling System
18. Hydraulic Cooling System
19. Paper(Belt)filter System
20. Oil Skimmer System
21. (Up to 45°C Capacity)
22. Specified Sub Table, T-slot, Machine Color
23. Extra Load Capacity



New column design increases contact surface with crossbeam and also with the ground foundation. The machine is stable because this structure.

SV FLOOR SPACE

6130 / 8130 / 10130 / 12130 / 14130 / 18730
(2000SV / 3000SV / 4000SV / 5000SV / 6000SV / 8000SV)

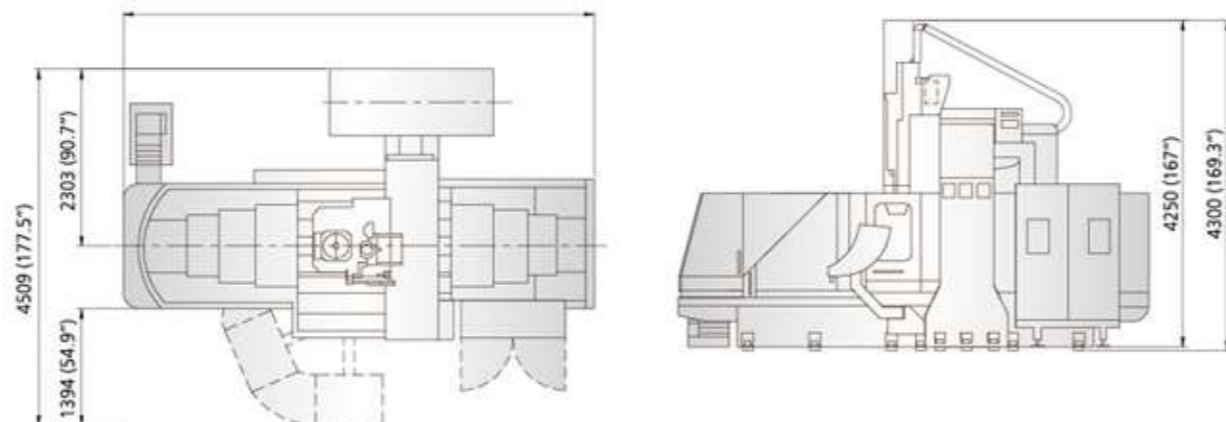

SD FLOOR SPACE

6130 / 8130 / 10130 / 12130 / 14130 / 18730
(2000SD / 3000SD / 4000SD / 5000SD / 6000SD / 8000SD)

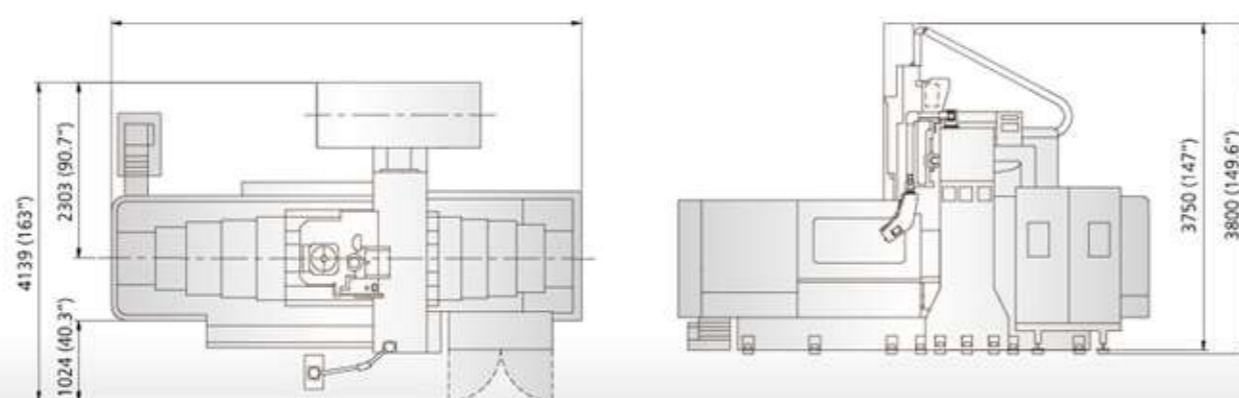

SPECIFICATIONS

Unit: mm (inch)

ITEM	KMC-2000SV/SD						KMC-3000SV/SD						KMC-4000SV/SD						KMC-5000SV/SD						KMC-6000SV/SD						KMC-8000SV/SD											
	A	B	C	D	E	F	A	B	C	D	E	F	A	B	C	D	E	F	A	B	C	D	E	F	A	B	C	D	E	F	A	B	C	D	E	F	A	B	C	D	E	F
Distance Between Two Columns	1500	1800	2100	---	---	---	1500	1800	2100	2300	2500	2800	1500	1800	2100	2300	2500	2800	1500	1800	2100	2300	2500	2800	1500	1800	2100	2300	2500	2800	1500	1800	2100	2300	2500	2800	1500	1800	2100	2300	2500	2800
	(59.05)	(70.86)	(82.6)	---	---	---	(59.05)	(70.86)	(82.6)	(90.55)	(98.43)	(110.2)	(59.05)	(70.86)	(82.6)	(90.55)	(98.43)	(110.2)	(59.05)	(70.86)	(82.6)	(90.55)	(98.43)	(110.2)	(59.05)	(70.86)	(82.6)	(90.55)	(98.43)	(110.2)	(59.05)	(70.86)	(82.6)	(90.55)	(98.43)	(110.2)	(59.05)	(70.86)	(82.6)	(90.55)	(98.43)	(110.2)
Table Size	1250	1650	1650	---	---	---	1250	1650	1650	2000	2000	2400	1250	1650	1650	2000	2000	2400	1250	1650	1650	2000	2000	2400	1250	1650	1650	2000	2000	2400	1250	1650	1650	2000	2000	2400	1250	1650	1650	2000	2000	2400
	(49.21)	(64.96)	(64.96)	---	---	---	(49.21)	(64.96)	(64.96)	(78.74)	(78.74)	(94.5)	(49.21)	(64.96)	(64.96)	(78.74)	(78.74)	(94.5)	(49.21)	(64.96)	(64.96)	(78.74)	(78.74)	(94.5)	(49.21)	(64.96)	(64.96)	(78.74)	(78.74)	(94.5)	(49.21)	(64.96)	(64.96)	(78.74)	(78.74)	(94.5)	(49.21)	(64.96)	(64.96)	(78.74)	(78.74)	(94.5)
Load Capacity	6000 kg (13200 lb)						9000 kg (19800 lb)						11000 kg (24200 lb)						13000 kg (28600 lb)						15000 kg (33000 lb)						17000 kg (37400 lb)											
	---						12000 kg (26400 lb)						14000 kg (30800 lb)						16000 kg (35200 lb)						18000 kg (39600 lb)						20000 kg (44000 lb)											
X axis Table Travel (Forth and Back)	2230 (87.8")						3230 (127.16")						4230 (166.53")						5230 (205.90")						6230 (245.27")						8230 (324.01")											
Y axis Spindle Head Travel (Left And Right)	1400	1700	2000	---	---	---	1400	1700	2000	2200	2400	2700	1400	1700	2000	2200	2400	2700	1400	1700	2000	2200	2400	2700	1400	1700	2000	2200	2400	2700	1400	1700	2000	2200	2400	2700	1400	1700	2000	2200	2400	2700
	(55.11)	(66.92)	(78.74)	---	---	---	(55.11)	(66.92)	(78.74)	(86.6)	(94.5)	(106.3)	(55.11)	(66.92)	(78.74)	(86.6)	(94.5)	(106.3)	(55.11)	(66.92)	(78.74)	(86.6)	(94.5)	(106.3)	(55.11)	(66.92)	(78.74)	(86.6)	(94.5)	(106.3)	(55.11)	(66.92)	(78.74)	(86.6)	(94.5)	(106.3)	(55.11)	(66.92)	(78.74)	(86.6)	(94.5)	(106.3)
Z-axis Spindle Head Travel (Up and Down)	SV						SD						850 (33.46")						700 (27.65")						700 (27.65")																	
Distance From Spindle Nose To Table Top	SV						SD						200 - 1050 (7.87" - 41.34")						200 - 900 (7.87" - 35.43")						200 - 900 (7.87" - 35.43")																	
Spindle Taper	SV						SD						ISO 50						ISO 50						ISO 50																	
Spindle Speed	SV						SD						20 - 3200 (*35 - 6000 rpm)						20 - 3200 (*35 - 6000 rpm)						20 - 3200 (*35 - 6000 rpm)																	
No. of spindle speed	SV						SD						Infinite variable, 2 steps						Infinite variable, 2 steps						Infinite variable, 2 steps																	
Rapid Traverse Rate (X)	mm/min						mm/min						mm/min						mm/min						mm/min																	
	15000 (590ipm)						15000 (590ipm)						12000 (472ipm)						8000 (315ipm)						8000 (315ipm)						7000 (276ipm)											
Rapid Traverse Rate (Y)	mm/min						mm/min						mm/min						mm/min						mm/min						mm/min											
	15000 (590ipm)						15000 (590ipm)						12000 (472ipm)						15000 (590ipm)						12000 (472ipm)						15000 (590ipm)						12000 (472ipm)					
Rapid Traverse Rate (Z)	mm/min						mm/min						mm/min						mm/min						mm/min						mm/min											
	12000 (472ipm)						12000 (472ipm)						12000 (472ipm)						12000 (472ipm)						12000 (472ipm)						12000 (472ipm)											
Cutting Feed Rate	mm/min						mm/min						mm/min						mm/min						mm/min						mm/min											
	1 - 8000 (0.1-315ipm)						1 - 8000 (0.1-315ipm)						1 - 8000 (0.1-315ipm)						1 - 5000 (0.1-197ipm)						1 - 5000 (0.1-197ipm)						1 - 5000 (0.1-197ipm)											
Main Spindle Motor (Continuous / 30min)	AC 20 HP / 25 HP (*30 HP / 35 HP)						AC 20 HP / 25 HP (*30 HP / 35 HP)						AC 20 HP / 25 HP (*30 HP / 35 HP)						AC 20 HP / 25 HP (*30 HP / 35 HP)						AC 20 HP / 25 HP (*30 HP / 35 HP)																	
Minimum Input Increment	0.001 (0.0001")						0.001 (0.0001")						0.001 (0.0001")						0.001 (0.0001")						0.001 (0.0001")																	
Tool	Tool Magazine Capacity - 30(*40,*50,*60,*90) Tools						Tool Selection Method - Shortest path						Tool Shank Shape: MAS403-BT50						Max. Tool Weight: 20 kg						Tool Pull Stud: MAS-P50T-1																	
	Max. Tool Length - 350 (13.8")						Max. Tool Diameter - ø130(5.11"), (ø200/7.87")						MAS403-BT50						20 kg						MAS-P50T-1																	
Positioning Accuracy	±0.005 / 300 (±0.0002"/12")						±0.005 / 300 (±0.0002"/12")						±0.005 / 300 (±0.0002"/12")						±0.005 / 300 (±0.0002"/12")						±0.005 / 300 (±0.0002"/12")						±0.005 / 300 (±0.0002"/12")											
	±0.01 (±0.0004")/Full Travel						±0.01 (±0.0004")/ Full Travel						±0.015 (±0.0006")/ Full Travel						±0.015 (±0.0006")/ Full Travel						±0.015 (±0.0006")/ Full Travel						±0.015 (±0.0006")/ Full Travel											
Repeatability Accuracy	±0.003 (±0.0001")						±0.003 (±0.0001")						±0.003 (±0.0001")						±0.003 (±0.0001")						±0.003 (±0.0001")																	
Floor Space Requirement (L X W)	6130	8130	10130	12130	14130	18730	6130	8130	10130	12130	14130	18730	6130	8130	10130	12130	14130	18730	6130	8130	10130	12130	14130	18730	6130	8130	10130	12130	14130	18730	6130	8130	10130	12130	14130	18730	6130	8130	10130	12130	14130	18730
	(241.3)	(320.1)	(320.1)	(320.1)	(320.1)	(320.1)	(241.3)	(320.1)	(320.1)	(320.1)	(320.1)	(320.1)	(241.3)	(320.1)	(320.1)	(320.1)	(320.1)	(320.1)	(241.3)	(320.1)	(320.1)	(320.1)	(320.1)	(320.1)	(241.3)	(320.1)	(320.1)	(320.1)	(320.1)	(320.1)	(241.3)	(320.1)	(320.1)	(320.1)	(320.1)	(320.1)	(241.3)	(320.1)	(320.1)	(320.1)	(320.1)	(320.1)
Machine Height	SV						SD						3800 (149.6")						3800 (149.6")						3800 (149.6")																	
	4139 (163")						3750 (147")						3750 (147")						3750 (147")						3750 (147")																	
Net Weight (Kg)	18500	19500	21300	---	---	---	23500	24500	25500	29500	31000	32000	29000	29500	31000	36500	37500	39000	33500	36000	37500	46000	47000	47500	37000	39500	41000	51500	52000	53000	48000	51000	52500	62000	63000	65000						
	(40700)	(43010)	(46860)	---	---	---	(51700)	(53900)	(56100)	(64900)	(68200)	(70400)	(63800)	(64900)	(68200)	(80300)	(82500)	(85800)	(73700)	(79200)	(82500)	(101200)	(103400)	(104500)	(114500)	(121200)	(126600)	(156000)	(156000)	(156000)	(105600)	(112200)	(115500)	(136400)	(138000)	(143000)						
Power Supply	55 KVA						55 KVA						55 KVA						55 KVA						55 KVA																	
CNC Controller	FANUC-0i (*31i) series						*HEIDENHAIN						*SIEMENS						*MITSUBISHI																							

OPTION / Design and specification are subject to change without notice. (L) Max. tool diameter (without adjacent tools) / Distance between two columns A=1500mm(59.05"), B=1800mm(70.86"), C=2100mm(82.6"), D=2300mm(90.55"), E=2500mm(98.43"), F=2800mm(110.2")

KMC-SV-H

DOUBLE COLUMN TYPE FIVE-FACE MACHINING CENTER (HORIZONTAL ANGULAR ATTACHMENT)

MAIN FEATURES

- / Based on SV construction and new features.
- / Combines the advantages of machining all 4 sides with angular attachment and machining the top face with vertical spindle head in one set-up.
- / AAC (Automatic Attachment Changer) is designed for improving productivity.
- / 2-station AAC magazine is located at the CRT side includes an automatic opening door, protecting the attachments from chips and coolant.
- / Since the spindle is driven by a powerful 26 KW (35 HP) spindle motor and through two-speed transmission by gears, the maximum spindle torque is a powerful 780 Nm (575 ft-lb), allowing heavy-duty cutting.
- / The spindle head is hydraulically clamped to the curvic coupling.
- / Tool can be easily unloaded/loaded from the horizontal spindle by operating a foot-switch.
- / Horizontal spindle employed high-precision hardened and ground spiral bevel gears that could reduce shocks and noises effectively to ensure running stability
- / 22 KW / 3,500 rpm angular attachment can be indexed to four positions in 90° increments. It is indexed by the shortest path.
- / For complex workpieces, indexing to 72 positions in 5° increment is optional.
- / Five-face machining pattern software is standard.



HORIZONTAL HEAD SPINDLE SPIRAL BEVEL GEAR TRANSMISSION

Horizontal-head spindle provides high precision spiral bevel gears, hardened and ground. This features reduce vibration and noise.

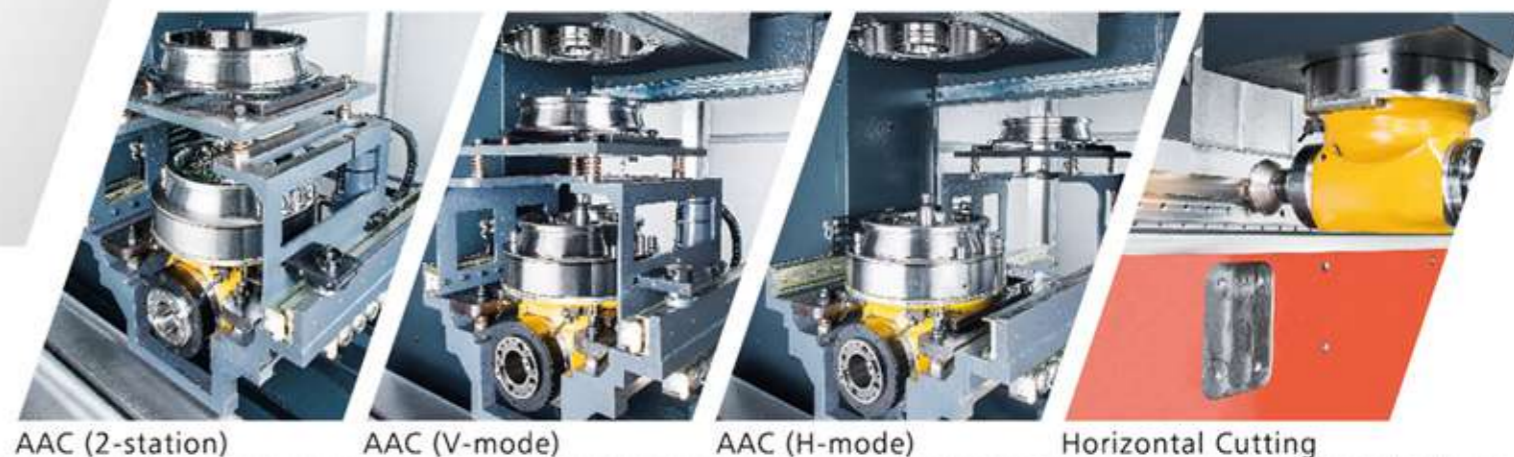

AAC (2-station)

AAC (V-mode)

AAC (H-mode)

Horizontal Cutting

KMC-SV-H

HORIZONTAL ANGULAR ATTACHMENT

Cutting Example (Test in the best environment)

Face Mill Cutter	∅125
Work Material	S45C
Spindle Speed	400 rpm
Cutting Width	100 mm
Cutting Depth	5 mm
Feedrate	880 mm/min
Cutting Capacity	440 cm ³ /min



MACHINING RANGE (SV-H):

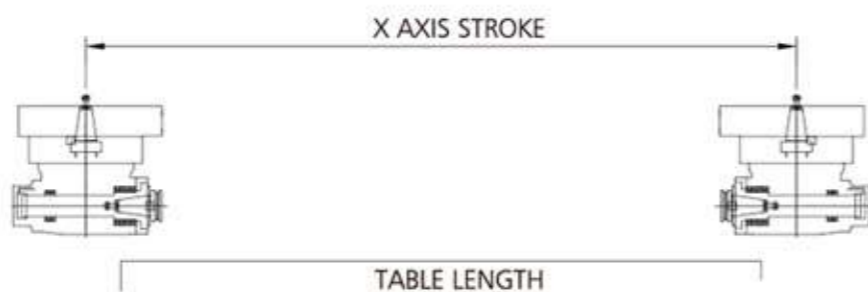
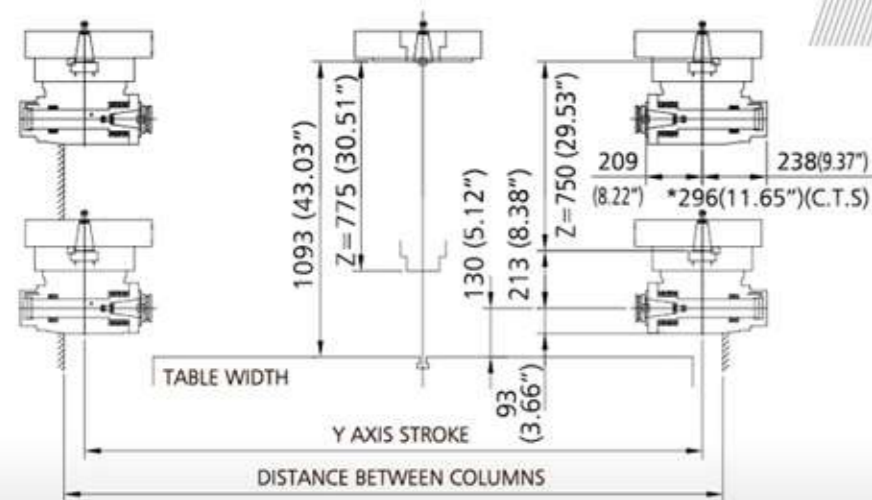

Distance between columns	2100	2300	2500	2800
Y axis stroke	1950 (76.77")	2150 (84.64")	2350 (92.51")	2650 (104.3")
H-mode	1950 (76.77")	2150 (84.64")	2350 (92.51")	2650 (104.3")

ITEM	KMC-3000SV-H	KMC-4000SV-H	KMC-5000SV-H	KMC-6000SV-H	KMC-8000SV-H
X axis stroke	3230 (127.16")	4230 (166.53")	5230 (205.90")	6230 (245.27")	8230 (324.01")
H-mode	3230 (127.16")	4230 (166.53")	5230 (205.90")	6230 (245.27")	8230 (324.01")

SPECIFICATIONS (with AAC-angular attachment changer)

Unit: mm (inch)

ITEM	KMC-3000SV-H				KMC-4000SV-H				KMC-5000SV-H				KMC-6000SV-H				KMC-8000SV-H																							
Distance Between Columns	C	D	E	F	2100 (82.6")	2300 (90.55")	2500 (98.43")	2800 (110.2")	2100 (82.6")	2300 (90.55")	2500 (98.43")	2800 (110.2")	2100 (82.6")	2300 (90.55")	2500 (98.43")	2800 (110.2")	2100 (82.6")	2300 (90.55")	2500 (98.43")	2800 (110.2")																				
Table Size	C	D	E	F	1650 (64.96")	2000 (78.74")	2000 (78.74")	2400 (94.5")	1650 (64.96")	2000 (78.74")	2000 (78.74")	2400 (94.5")	1650 (64.96")	2000 (78.74")	2000 (78.74")	2400 (94.5")	1650 (64.96")	2000 (78.74")	2000 (78.74")	2400 (94.5")																				
	D	E	F	3000 (118.11")	3000 (118.11")	3000 (118.11")	3000 (118.11")	4000 (157.48")	4000 (157.48")	4000 (157.48")	4000 (157.48")	5000 (196.85")	5000 (196.85")	5000 (196.85")	5000 (196.85")	6000 (236.22")	6000 (236.22")	6000 (236.22")	6000 (236.22")																					
	F	118.11"	118.11"	118.11"	118.11"	157.48"	157.48"	157.48"	157.48"	196.85"	196.85"	196.85"	196.85"	236.22"	236.22"	236.22"	236.22"	314.96"	314.96"	314.96"																				
Load Capacity	C				9000 kg (19800 lb)				11000 kg (24200 lb)				13000 kg (28600 lb)				15000 kg (33000 lb)				17000 kg (37400 lb)																			
	D E F				12000 kg (26400 lb)				14000 kg (30800 lb)				16000 kg (35200 lb)				18000 kg (39600 lb)				20000 kg (44000 lb)																			
X axis Table Travel	V / H				3230 (127.16")				4230 (166.53")				5230 (205.90")				6230 (245.27")				8230 (324.01")																			
Y axis Spindle Head Travel	V / H				1950 (76.77")	2150 (84.64")	2350 (92.51")	2650 (104.3")	1950 (76.77")	2150 (84.64")	2350 (92.51")	2650 (104.3")	1950 (76.77")	2150 (84.64")	2350 (92.51")	2650 (104.3")	1950 (76.77")	2150 (84.64")	2350 (92.51")	2650 (104.3")																				
Z axis Spindle Head Travel	V				775 (30.51")				H				750 (29.53")																											
Spindle Taper (V / H)	ISO 50																																							
Spindle Speed	V				4400 rpm (*6000 rpm)																																			
	H				3500 rpm																																			
No. Of Spindle Speed	Infinite variable, 2 steps																																							
Rapid Traverse Rate (X,Y,Z)	m/min (15,15,12)				(15, 12, 12)				(12,15,12)				(12, 12, 12)				(8,15,12)				(8,12,12)				(8,15,12)				(8,12,12)				(7,15,12)				(7,12,12)			
Main Spindle Motor (Continuous / 30 min)	AC 22 kw / 26 kw (30 HP / 35 HP)																																							
Tool Magazine Capacity	30 (*40,*50,*60,*90)																																							
Positioning Accuracy	±0.005 / 300(±0.002"/12")				±0.005 / 300(±0.0002"/12")				±0.005 / 300(±0.0002"/12")				±0.005 / 300(±0.0002"/12")				±0.005/300(±0.0002"/12")				±0.005/300(±0.0002"/12")																			
	±0.01 (±0.0004 / Full Travel)				±0.015(±0.0006") / Full Travel				±0.015(±0.0006") / Full Travel				±0.015(±0.0006") / Full Travel				±0.015(±0.0006") / Full Travel				±0.015(±0.0006") / Full Travel																			
Repeatability Accuracy	±0.003 (±0.0001")																																							
Attachment Indexing	90°×4 (*5°×72)																																							
Index Repeatability	±3 Sec																																							

OPTION / Design and specification are subject to change without notice. / Distance between columns C=2100 mm(82.6"), D=2300 mm(90.55"), E=2500 mm(98.43"), F=2800 mm(110.2")



KAO MING MACHINERY INDUSTRIAL CO., LTD.

<http://www.kaoming.com>

HEAD OFFICE

No.67, Ln. 209, Sec.2, Sanfong Rd., Fongyuan Dist., Taichung City 42054, Taiwan (R.O.C.)

CTSP

No.53, Houke S. Rd., Houli District, Taichung City, 42152 Taiwan.

TEL: +886-4-25577650 FAX: +886-4-25577630

E-MAIL: km@kaoming.com.tw



KM Web

Cat.32 1802(E)*2000F



KAO MING
50
1968-2018



BRIDGE

PRESENT AND FUTURE

KMC-SV / SV-H Series KMC-SD Series

KAO MING MACHINERY INDUSTRIAL CO., LTD.